

# MODEL HS35

## INCREMENTAL OPTICAL ENCODER

### Introduction

The HS35 combines the rugged, heavy-duty features usually associated with shafted encoders into a hollow shaft style. Its design includes dual bearings and shaft seals for NEMA 4, 13 and IP65 environmental ratings, a rugged metal housing, and a sealed connector or cable gland. The HS35 accommodates shafts up to 1" in diameter. With optional insulating inserts, it can be mounted on smaller diameter shafts. It can be mounted on a through shaft or a blind shaft with a closed cover to maintain its environmental rating. The HS35 is also available with a dual output option (inset) to provide redundant encoder signals, dual resolutions, or to supply two separate controllers from a single encoder. Applications include motor feedback and vector control, printing industries, robotic control, oil service industries, and web process control.



### SPECIFICATIONS

The HS35 Dual Output Encoder

#### Mechanical

<b>Shaft Bore</b>	1.00", 0.875", 0.750", 0.625", 0.500". All are supplied with insulating sleeves.
<b>Allowable Misalignments</b>	0.005" T.I.R. on mating shaft 0.75" from shaft end
<b>Bore Runout</b>	0.001 T.I.R. maximum
<b>Starting Torque at 25°C</b>	Through shaft version (SS) = 7 in-oz (max); Blind shaft version (BS) = 4 in-oz max
<b>Bearings</b>	52100 SAE High carbon steel
<b>Shaft Material</b>	416 stainless steel
<b>Bearing Housing</b>	Die cast aluminum with protective finish
<b>Cover</b>	Die cast aluminum with protective finish
<b>Bearing Life</b>	7.5 X 10 <sup>9</sup> revs (50,000 hrs at 2500 RPM)
<b>Maximum RPM</b>	6,000 RPM (see frequency response above)
<b>Moment of Inertia</b>	0.019 oz-in-sec <sup>2</sup>
<b>Weight</b>	18 oz. typical

## Electrical

<b>Code</b>	Incremental
<b>Output Format</b>	2 channels in quadrature, 1/2 cycle index gated with negative B channel
<b>Cycles per Shaft Turn</b>	1 to 80,000 (See Table A). For resolutions above 5000 see interpolation options in Table A
<b>Supply Voltage</b>	5 to 28 VDC available (See Note 5)
<b>Current Requirements</b>	100 mA typical + output load, 250 mA (max)
<b>Voltage / Output</b>	15V/V: 5–15 VDC in, $V_{out} = V_{in}$ 28V/V: Line Driver, 5–28 VDC in, $V_{out} = V_{in}$ 28V/5: Line Driver, 5–28 VDC in, $V_{out} = 5$ VDC 28V/OC: Open Collector, 5–28 VDC in, $OC_{out}$ (See Note 5)
<b>Protection Level</b>	Reverse, overvoltage and output short circuit protection (See Note 5)
<b>Frequency Response</b>	150 kHz (Up to 5000 cpt resolution; 300 KHz above 5000 cpt, also see Note 7)
<b>Output Termination Pinouts</b>	See Table 1

**Notes:** Consult factory for other electrical options.

## Environmental

<b>Enclosure Rating</b>	NEMA 4 & 13 (IP65) when ordered with shaft seal (on units with an MS connector) or a cable gland (on units with cable termination)
<b>Temperature</b>	Operating, 0° to 70° C; extended temperature testing up to 105° C available (see Note 8); Storage, -25° to 90° C unless extended temperature option called out
<b>Shock</b>	50 g's for 11 msec duration
<b>Vibration</b>	5 to 2000 Hz @ 20 g's
<b>Humidity</b>	98% RH without condensation

**Notes and Tables:** All notes and tables referred to in the text can be found in the pages that follow.



# DIMENSIONS

Dimensions in mm

## MS Connector Termination



## Cable Termination



## R1 Tether Block and Pin

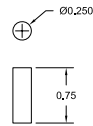

## R2 Tether Arm



## Dual Output

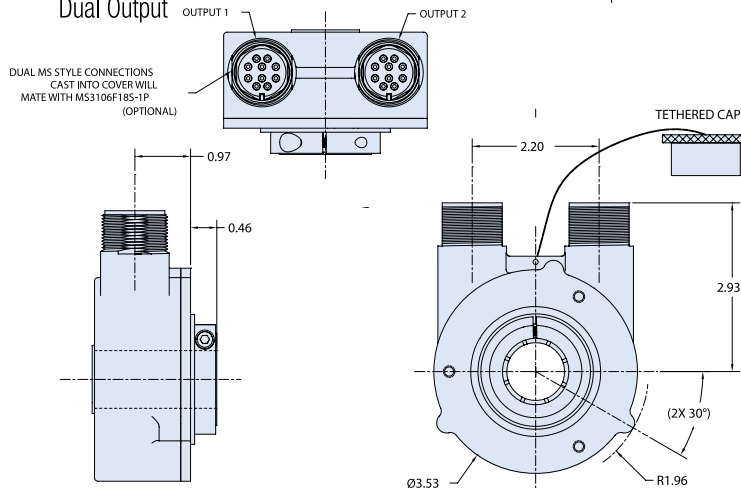

**Table 1 —**  
Incremental Output Terminations

The connector style will determine pinouts.  
For example, an encoder with ABC channels and an M18 connector uses the table below.

M18 Connector		M12 Connector		M16 Connector	Channels Designated in Model No.	
Pin	Channel	Pin	Channel	PIN	ABZ	ABC
A	A	A	A	A	A	A
B	B	B	B	B	B	B
C	Z	C	Z	C	Z	$\bar{A}$
D	+V	D	+V	D	+V (Supply Voltage)	
E	—	E	—	E	—	$\bar{B}$
F	0V	F	0V	F	0V (Circuit Common)	
G	CG	G	CG	G	Case Ground (CG) (Except H20)	
H	$\bar{A}$	H	$\bar{A}$			
I	$\bar{B}$	J	$\bar{B}$			
J	$\bar{Z}$	k	$\bar{Z}$			

Wire Color	DA 15P Connector	Channels Designated in Model No.		
		ABZ	ABC	ABZC
YEL	13	A	A	A
BLUE	14	B	B	B
ORN	15	Z	—	Z
W-Yel	10	—	$\bar{A}$	$\bar{A}$
W-Blu	11	—	$\bar{B}$	$\bar{B}$
W-Orn	12	—	—	$\bar{Z}$
RED	6	+V (Supply Voltage)		
BLK	1	0V (Circuit Common)		
GRN	9	Case Ground (CG) (Except H20)		
WHITE		Shield Drain (Shielded Cable Only)		

**Table A —**  
HS35 Disc Resolutions

32, 100, 250, 360, 420, 500, 512, 600, 635, 720, 1000, 1024, 1200, 1500, 1650, 1800, 2000, 2100, 2048, 2500, 2881, 2884, 3600, 3710, 4096, 5000

For interpolation please specify the multiplied output (up to 80,000 for the HS35) in the model number, i.e. 80,000-T16. Other resolutions available—consult factory.  
**NOTE:** Dual resolutions available, consult factory.

**Figure 1** —  
Output Waveform



**NOTE:** Index location is displaced 180° (mechanical) on second output with dual output option.



# ORDERING OPTIONS

**EXPRESS ENCODERS:** Items highlighted with this are standard Express Encoders and ship in few days.

**X** **HS35** **F** - **100** - **R1** - **SS** - **2048** **ABZ** **C** - **28V/V** - **SM18** - **EX** - **S**

**Encoder** **X:** Express Encoder

**Type** **HS:** Hollow Shaft  
**35:** 3.5" Encoder Diameter

**Housing Configuration** **F:** Standard

**Shaft Bore** **100:** 1.00" **62:** 0.625"  
**87:** 0.875" **50:** 0.50" etc.  
**75:** 0.75" Metric bores available

**Tether** **R1:** Tether Block and Pin  
**R2:** Tether Arm

**Shaft Seal Configuration** **SS:** Through Shaft, Rubber Seals **BFS:** Blind Shaft Felt (See Note 2)  
**BS:** Blind Shaft, Rubber Seal  
**FS:** Through Shaft, Felt Seals

**Cycles per Turn** (Enter Cycles)  
(See table A on the prior pages)

**No. of Channels** **ABZ**  
(See Note 3)

**Compliments** **C:** Complimentary Outputs  
(See Note 4)

**Voltage / Output** **15V/V:** 5-15V<sub>in/out</sub> **28V/5:** 5-28V<sub>in</sub>/5V<sub>out</sub> (See Note 5)  
**28V/V:** 5-28V<sub>in/out</sub> **28V/OC:** 5-28V<sub>in</sub>/OC<sub>out</sub>

**Output Termination** **SM12:** MS3112E12-10P  
**M16:** MS3102R16S-1P  
**SM18:** MS3102R18-1P  
(Indicate "S" for single or "D" for Dual (i.e. DM18 = Dual)  
**SCS:** Shielded/Jacketed Cable with Cable Seal. Length of Cable is specified in inches. (i.e. SCS18 = 18 inches)  
(See Table 1 & Note 9)

**Hazardous Area Ratings** **Blank:** None **NI:** Non-Incendive  
**EX:** Intrinsically Safe Contact Factory for Voltage Options







**Special Features** **S:** Special Features specified on Purchase Order.  
(See Note 3)  
(Consult Factory for More Information)

1. The typical hollow shaft product is supported by, and clamped to, the driving shaft. A flexible tether is used to keep the housing from rotating.
  2. The rubber shaft seal is recommended in virtually all installations. The most common exceptions are applications requiring a very low starting torque or those requiring operation at both high temperature and high speed. For these exceptions, a felt shaft seal is recommended. Felt seals require very low starting torque and can virtually eliminate frictional heat. Encoders ordered with felt shaft seals will have an enclosure rating of IP50 and will have less than 1/10th the Starting Torque specified under Mechanical Configurations.
  3. Non-standard index widths and multiple indices are available by special order. Consult factory.
  4. Complementary outputs are recommended for use with line driver type (source/sink) outputs. When used with differential receivers, this combination provides a high degree of noise immunity.
  5. **Output IC's:** Output IC's are available as either Line Driver (LD) or NPN Open Collector (OC) types. Open Collectors require pull-up resistors, resulting in higher output source impedance (sink impedance is similar to that of line drivers). In general, use of a Line Driver style output is recommended. Line Drivers source or sink current and their lower impedance mean better noise immunity and faster switching times. Warning: Do not connect any line driver outputs directly to circuit common/OV, which may damage the driver. Unused outputs should be isolated and left floating. Our applications specialists would be pleased to discuss your system requirements and the compatibility of your receiving electronics with Line Driver type outputs.
- 28V/V: Multi-Voltage Line Driver (7272\*):** 100 mA source/sink. Input voltage 5 to 28 VDC  $\pm$  5% standard (Note:  $V_{out} = V_{in}$ ). This driver is TTL compatible when used with 5 volt supply. Supply lines are protected against overvoltage to 60 volts and reverse voltage. Outputs are short circuit protected for one minute. Supply current is 120 mA typical (plus load current). This is the recommended replacement for 3904R and 7406R open collector outputs with internal pullup resistors. It is also a direct replacement for any 4469, 88C30, 8830 or 26LS31 line driver
- 28V/5:** Multi-voltage Line Driver (7272\*): 100 mA source/sink. Input voltage 5 to 28 VDC  $\pm$  5% standard, internally regulated with 5V (TTL compatible) logic out. Supply lines are protected against overvoltage to 60 volts and reverse voltage. Outputs are short circuit protected for one minute. Supply current is 90 mA typical (plus load current).
- 28V/OC:** NPN Open Collector (3904\*, 7273\*). Current sink of 80 mA max. Current sourced by external pull-up resistor. Output can be pulled up to voltage other than supply voltage (30 V max). Input voltage 5 to 28 VDC  $\pm$  5% standard. Supply current is 120 mA typical. This replaces prior IC's with designations of 3904, 7406, 3302, 681 and 689.
- 5V/OCR, 15V/OCR, 24V/OCR:** Open Collector (3904R\*, 7406R\*, 7273R\*): Current sink of 70 mA max. Includes internal pull-ups sized at approximately 100 ohms/volt. Max current source is 10 mA. Supply current is 100 mA typical, 120 mA with internal pull-ups. The 5V/OCR, 15V/OCR and 24V/OCR are often replaced by the 28V/V in system upgrades.
- Intrinsically Safe Voltage/Output options:** 5V/V, 5V/OC, 5V/OCR, 9V/OC are the only output options available with the Intrinsically Safe "EX" Hazardous Area Rating model option. They must be installed per Control Drawing 08292-001.
6. **Special** –S at the end of the model number is used to define a variety of non-standard features such as special shaft lengths, voltage options, or special testing. Please consult the factory to discuss your special requirements.
  7. Higher frequency response may be available. Please consult with the factory.
  8. Extended temperature ratings are available in the following ranges: -40 to 70°C, -40 to 85°C, -20 to 105°C and -40 to 105°C depending on the particular model. Some models can operate down to -55°C. Extended temperature ranges can affect other performance factors. Consult with factory for more specific information.
  9. Mating straight plug receptacles may be ordered from the factory:

For M12 use MS3116F12-10S  
For M14 use MS3106F14S-6S

For M14/19 use MS3116J14-19S  
For M16 use MS3106F16S-1S

For M18 use MS3106F18-1S  
For M20 use MS3106F20-29S

Model HS35 Hazardous Area Ratings	Agency		Ratings and Markings	File Number
Blank		CE	EN 55011: Electromagnetic Disturbance (EMI) EN 61000-6-2: Electromagnetic Compatibility (EMC)	
EX Intrinsic Safety		UL	Class I, Groups A, B, C, D Class II, Groups E, F, G	20180302-E78446
		DEMKO	II 1 G Ex ia IIC T4 Ga (9V/OC is II 1 G Ex ia IIB T4 Ga)	DEMKO 06 ATEX 0614247X
		IEC/IECEx	Ex ia IIC T4 Ga (9V/OC is Ex ia IIB T4 Ga) -40°C ≤ Ta ≤ +85°C	IECEx UL 12.0035X
NI Non-Incendive		UL	Class I, Div. 2, Groups A, B, C, D Class II, Div. 2, Groups F, G	20170321-E78446
		DEMKO	II 3 G Ex nA IIB T3 Gc	DEMKO 13 ATEX 1209038X
		IEC/IECEx	Ex nA IIB T3 Gc -40°C ≤ Ta ≤ +85°C	IECEx UL 13.0071X

Sensata Technologies, Inc. ("Sensata") data sheets are solely intended to assist designers ("Buyers") who are developing systems that incorporate Sensata products (also referred to herein as "components"). Buyer understands and agrees that Buyer remains responsible for using its independent analysis, evaluation and judgment in designing Buyer's systems and products. Sensata data sheets have been created using standard laboratory conditions and engineering practices. Sensata has not conducted any testing other than that specifically described in the published documentation for a particular data sheet. Sensata may make corrections, enhancements, improvements and other changes to its data sheets or components without notice.

Buyers are authorized to use Sensata data sheets with the Sensata component(s) identified in each particular data sheet. HOWEVER, NO OTHER LICENSE, EXPRESS OR IMPLIED, BY ESTOPPEL OR OTHERWISE TO ANY OTHER SENSATA INTELLECTUAL PROPERTY RIGHT, AND NO LICENSE TO ANY THIRD PARTY TECHNOLOGY OR INTELLECTUAL PROPERTY RIGHT, IS GRANTED HEREIN. SENSATA DATA SHEETS ARE PROVIDED "AS IS". SENSATA MAKES NO WARRANTIES OR REPRESENTATIONS WITH REGARD TO THE DATA SHEETS OR USE OF THE DATA SHEETS, EXPRESS, IMPLIED OR STATUTORY, INCLUDING ACCURACY OR COMPLETENESS. SENSATA DISCLAIMS ANY WARRANTY OF TITLE AND ANY IMPLIED WARRANTIES OF MERCHANTABILITY, FITNESS FOR A PARTICULAR PURPOSE, QUIET ENJOYMENT, QUIET POSSESSION, AND NON-INFRINGEMENT OF ANY THIRD PARTY INTELLECTUAL PROPERTY RIGHTS WITH REGARD TO SENSATA DATA SHEETS OR USE THEREOF.

All products are sold subject to Sensata's terms and conditions of sale supplied at [www.sensata.com](http://www.sensata.com) SENSATA ASSUMES NO LIABILITY FOR APPLICATIONS ASSISTANCE OR THE DESIGN OF BUYERS' PRODUCTS. BUYER ACKNOWLEDGES AND AGREES THAT IT IS SOLELY RESPONSIBLE FOR COMPLIANCE WITH ALL LEGAL, REGULATORY AND SAFETY-RELATED REQUIREMENTS CONCERNING ITS PRODUCTS, AND ANY USE OF SENSATA COMPONENTS IN ITS APPLICATIONS, NOTWITHSTANDING ANY APPLICATIONS-RELATED INFORMATION OR SUPPORT THAT MAY BE PROVIDED BY SENSATA.

Mailing Address: Sensata Technologies, Inc., 529 Pleasant Street, Attleboro, MA 02703, USA.

## CONTACT US

### Americas

+1 (800) 350 2727 – Option 1  
[sales.beisensors@sensata.com](mailto:sales.beisensors@sensata.com)  
**Europe, Middle East & Africa**  
 +33 (3) 88 20 8080  
[position-info.eu@sensata.com](mailto:position-info.eu@sensata.com)

### Asia Pacific

[sales.isasia@list.sensata.com](mailto:sales.isasia@list.sensata.com)  
 China +86 (21) 2306 1500  
 Japan +81 (45) 277 7117  
 Korea +82 (31) 601 2004  
 India +91 (80) 67920890  
 Rest of Asia +886 (2) 27602006  
 ext 2808